

Data Sheet



Article number: 03445120

Description: Fluro Heavy Duty Spherical Plain Bearing GE 120 EW-2RS
Hole \varnothing 120

Note: 120

Measures

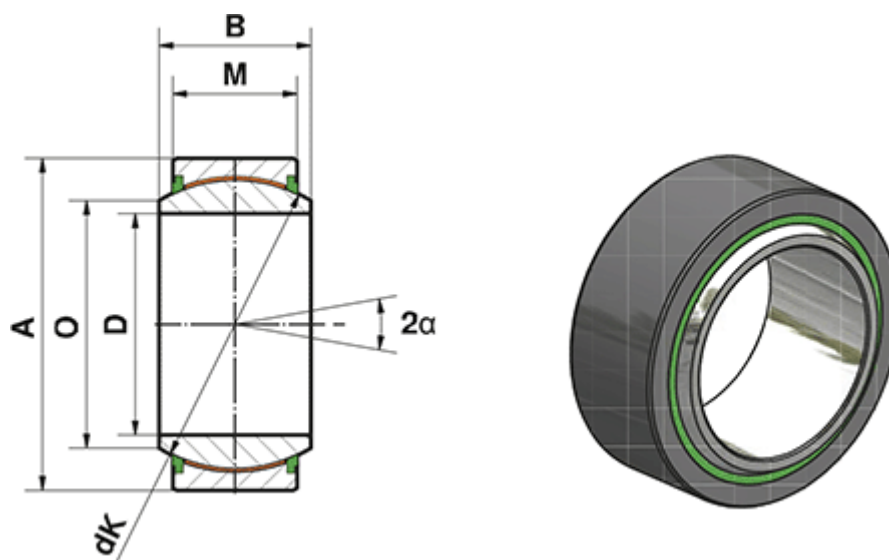

A	= 180	Static load C0 (kN) = 4475
a (degrees)	= 6	Weight (g) = 8100
B	= 85	
D	= 120	
dK	= 160	
Dynamic load C (kN)	= 2685	
M	= 70	
O	= 135.5	